

INSPECTION AND MAINTENANCE LOG



MODEL NUMBER: _____

DATE OF MANUFACTURE: _____

Part Number	Comments	Inspector Name

Inspection: Official periodic inspection must be made at least annually. The inspection must be performed by a qualified person other than the intended user. If severe weather or conditions exist then inspections must be carried out more frequently. All inspection results must be logged in the space provided above.

- 1. Inspect unit for visible signs of damage or wear that could affect operation. For example: kinked or frayed cables.
- 2. Make sure all labeling is affixed to the unit.
- 3. Check toggle and end termination operate smoothly with no metal burrs.
- 4. When reusing a previously drilled hole, inspect for debris or wallowing.
- 5. Record inspection results in the space provide above.

*** If any damage that could affect the strength or operation of the device, or unsafe conditions are found, proper disposal is required. The anchorage connector must be rendered unusable and then properly discarded.**

Product Warranty, Limited Remedy and Limitation of Liability

WARRANTY: THE FOLLOWING IS MADE IN LIEU OF ALL WARRANTIES OR CONDITIONS, EXPRESS OR IMPLIED, INCLUDING THE IMPLIED WARRANTIES OR CONDITIONS OF MERCHANTABILITY OR FITNESS FOR A PARTICULAR PURPOSE. Equipment offered by ClimbTech is warranted against factory defects in workmanship and materials for a period of one year from date of purchase.

LIMITED REMEDY: Upon notice in writing, ClimbTech will repair or replace all defective items at ClimbTech's sole discretion. ClimbTech reserves the right to require that the defective item be returned to its plant for inspection before determining the appropriate course action. Warranty does not cover equipment damage resulting from wear, abuse, damage in transit, failure to maintain the product or other damage beyond the control of ClimbTech. ClimbTech shall be the sole judge of product condition and warranty options. This warranty applies only to original purchaser and is the only warranty applicable to this product. Please contact ClimbTech technical service department for assistance.

LIMITATION OF LIABILITY: IN NO EVENT WILL CLIMBTECH BE LIABLE FOR ANY INDIRECT, INCIDENTAL, SPECIAL OR CONSEQUENTIAL DAMAGES INCLUDING, BUT NOT LIMITED TO LOSS OF PROFITS, IN ANY WAY RELATED TO THE PRODUCTS REGARDLESS OF THE LEGAL THEORY ASSERTED.



Toggle Bolt Anchor 5,000-lbf / 22kN Model: TLA075N Made in the USA

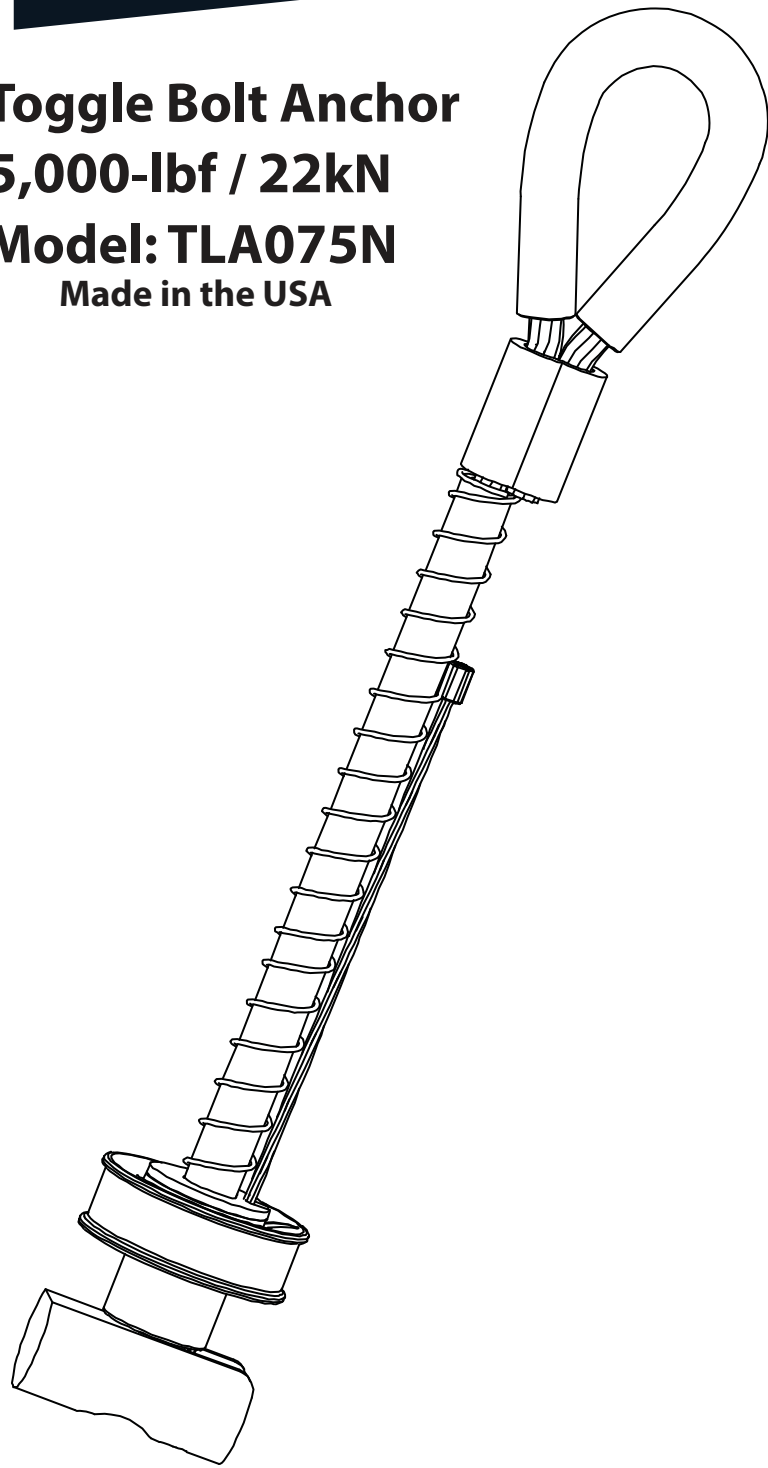

IMPORTANT!!!

ALL PERSONS USING THIS EQUIPMENT MUST READ AND UNDERSTAND ALL INSTRUCTIONS. FAILURE TO DO SO MAY RESULT IN SERIOUS INJURY OR DEATH. USERS SHOULD BE FAMILIAR WITH PERTINENT REGULATIONS GOVERNING THIS EQUIPMENT. ALL INDIVIDUALS WHO USE THIS PRODUCT MUST BE PROPERLY INSTRUCTED ON HOW TO USE THIS DEVICE.



Read This Instruction Manual Carefully Before Using This Equipment.

User Instructions must always be available to the user and are not to be removed except by the user of this equipment. For proper use, see supervisor, User Instructions, or contact the manufacturer.



Compliant fall protection and emergency rescue systems help prevent serious injury during fall arrest. Users and purchasers of this equipment must read and understand the User Instructions provided for correct use and care of this product. All users of this equipment must understand the instructions, operation, limitations and consequences of improper use of this equipment and be properly trained prior to use per OSHA 29 CFR 1910.66 and 1926.503 or applicable local standards. **Misuse or failure to follow warnings and instructions may result in serious personal injury or death.**

PURPOSE
The TLA075N is an anchorage connector designed to function as an interface between the anchorage and a fall protection, work positioning, rope access, or rescue system for the purpose of coupling the system to the anchorage. Any references to "anchorage connector" in this manual include, and apply to, the TLA075N.

- USE INSTRUCTIONS**
1. A user must be of sound mind and body to properly and safely use this equipment in normal and emergency situations. Users must have a physician ensure they are clear of any medical conditions that may affect the proper and safe use of this equipment in normal and emergency situations.
 2. Before using a personal fall arrest system, user must be trained in accordance with the requirements of OSHA 29 CFR 1910.66 in the safe use of the system and its components.
 3. Use only with ANSI/OSHA compliant personal fall arrest or restraint systems. The anchorage must have the strength capable of supporting a static load, applied in the directions permitted by the system, of at least 5,000-lbf (22kN) in the absence of certification.
 4. The user shall be equipped with a means of limiting the maximum dynamic forces exerted on the user during the arrest of a fall to a maximum of 6 kN (1350-lbf)
 5. Use of this product must be approved by an Engineer or other qualified person to be compatible with any and all structural & operational characteristics of the selected installation location and system to be connected to this anchorage connector.
 6. The anchorage connector must be inspected prior to each use for wear, damage, and other deterioration. If defective components are found the anchorage connector must be immediately removed from service in accordance with the requirements of OSHA 29 CFR 1910.66 and 1926.502.
 7. The anchorage connector should be positioned in such a way that minimizes the potential for falls and the potential fall distance during use. The complete fall protection system must be planned (including all components, calculating fall clearance, and swing fall) before using.
 8. A rescue plan, and the means at hand to implement it, must be in place that provides the prompt rescue of users in the event of a fall, or assures that users are able to rescue themselves.
 9. After a fall occurs the anchorage connector must be removed from service and destroyed immediately.

USE LIMITATIONS: The anchorage connector shall not be used outside its limitations, or for any purpose other than that for which it is intended.

1. The anchorage connector is designed for single user, with a capacity up to 310 lbs (140 kg) including clothing, tools, etc.
2. The anchorage connector may be pulled in any direction shown in the LOADING CONDITIONS DIAGRAM.
3. The anchorage connector is designed to be used in temperatures ranging from -40°F to +130°F (-40°C to +54°C).
4. Do not expose the anchorage connector to chemicals or harsh solutions which may have a harmful effect.
5. Do not alter or modify this product in anyway.
6. Caution must be taken when using any component of a fall protection, work positioning, rope access, or rescue system near moving machinery, electrical hazards, sharp edges, or abrasive surfaces, as contact may cause equipment failure, personal injury, or death.
7. Do not use/install equipment without proper training by a "competent person" as defined by OSHA 29 CFR 1926.32(f).
8. Do not remove the labeling from this product.
9. Additional requirements and limitations may apply depending on anchorage type and fastening option utilized for installation. All placements must be approved by an engineer or other qualified person.
10. This anchorage connector should not be used as part of a horizontal lifeline system that has not been designed and approved to be used with 5,000-lbf anchorage connectors.
11. The anchorage connector should only be used for personal fall protection and not for lifting equipment.

COMPATIBILITY LIMITATIONS
Anchorage connector must only be coupled to compatible connectors. OSHA 29 CFR 1926.502 prohibits snaphooks from being engaged to certain objects unless two requirements are met: it must be a locking type snaphook, and it must be "designed for" making such a connection. "Designed for" means that the manufacturer of the snaphook specifically designed the snaphook to be used to connect to the equipment listed. The following connections must be avoided, because they can result in rollout* when a nonlocking snaphook is used:

- Direct connection of a snaphook to horizontal lifeline.
 - Two (or more) snaphooks connected to one D-ring.
 - Two snaphooks connected to each other.
 - A snaphook connected back on its integral lanyard.
 - A snaphook connected to a webbing loop or webbing lanyard.
 - Improper dimensions of the D-ring, rebar, or other connection point in relation to the snaphook dimensions that would allow the snaphook keeper to be depressed by a turning motion of the snaphook.
- *Rollout: A process by which a snaphook or carabiner unintentionally disengages from another connector or object to which it is coupled. (ANSI Z359.1-2007)**

MAINTENANCE, CLEANING AND STORAGE
Cleaning periodically will prolong the life and proper functioning of the product. The frequency of cleaning should be determined by inspection and by severity of the environment. Clean with compressed air and/or a stiff brush using plain water or a mild soap and water solution. Do not use any corrosive chemicals that could damage the product. Wipe all surfaces with a clean dry cloth and hang to dry, or use compressed air. When not in use, store anchorage connectors in a cool, dry, clean environment, out of direct sunlight and free of corrosive or other degrading elements.

ClimbTech, LLC.
7303 Burleson Rd. Suite 901 Austin, TX 78744
1(512)308-6440 / www.climbtech.com

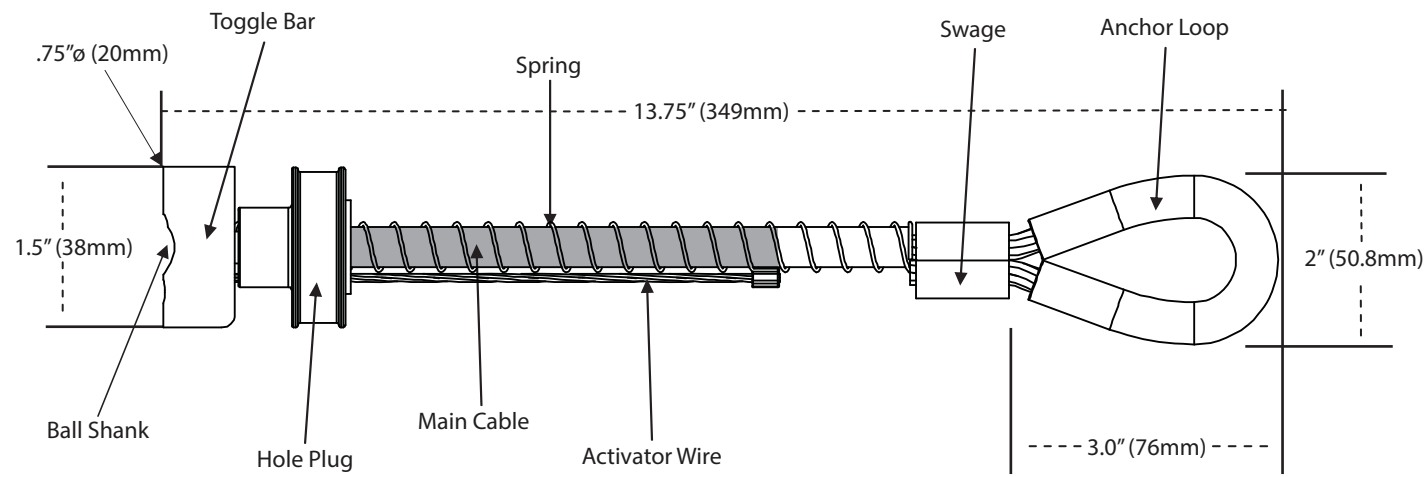

PERFORMANCE:
Static Tensile Strength: 5000-lbf (22kN)
Maximum Capacity: one worker with max weight of 310-lbs when used as a single point anchorage connector for personal fall arrest or restraint system.

DIMENSIONS:
Weight: .45-lbs (207g)
Length: 13.75" (349mm)
Diameter: .75 (19mm)

REGULATORY COMPLIANCE:
 ANSI Z359.1-2007, ANSI Z359.7-2011
 OSHA 1926.502, OSHA 1910.66
 EN 795:2012 Class A

COMPONENT MATERIALS:
Aluminum: Hole Plug, Trigger
Aircraft Cable: Main Cable, Activator Wire
Polyurethane: Loop Cover
Stainless Steel: Toggle Bar
Zinc Plated Steel: Spring
Zinc Plated Copper: Swage

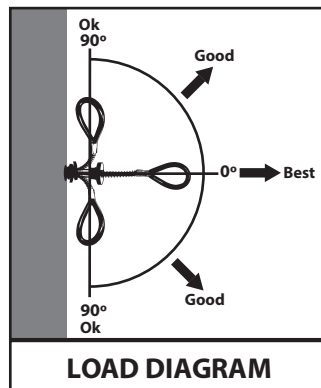

INSTALLATION:

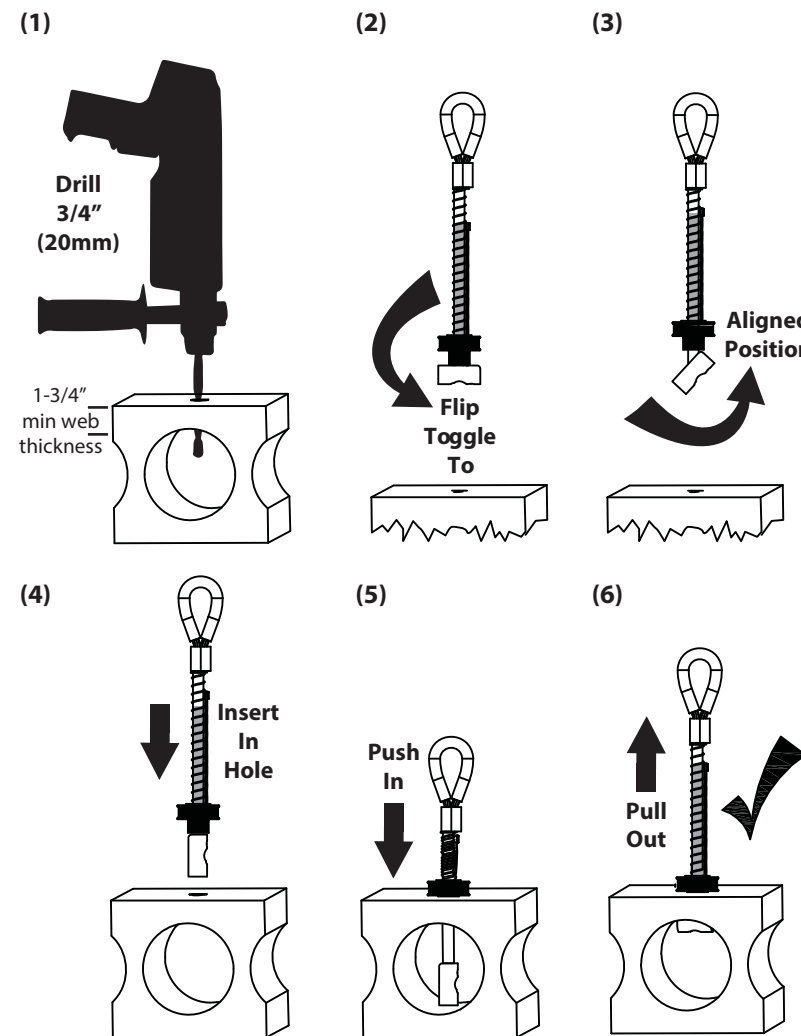

May be used as an anchoring point for a leading edge restraint system. Examples are of optional anchoring point locations. The use of two anchors is not required for leading edge restraint systems unless otherwise specified by the manufacturer.

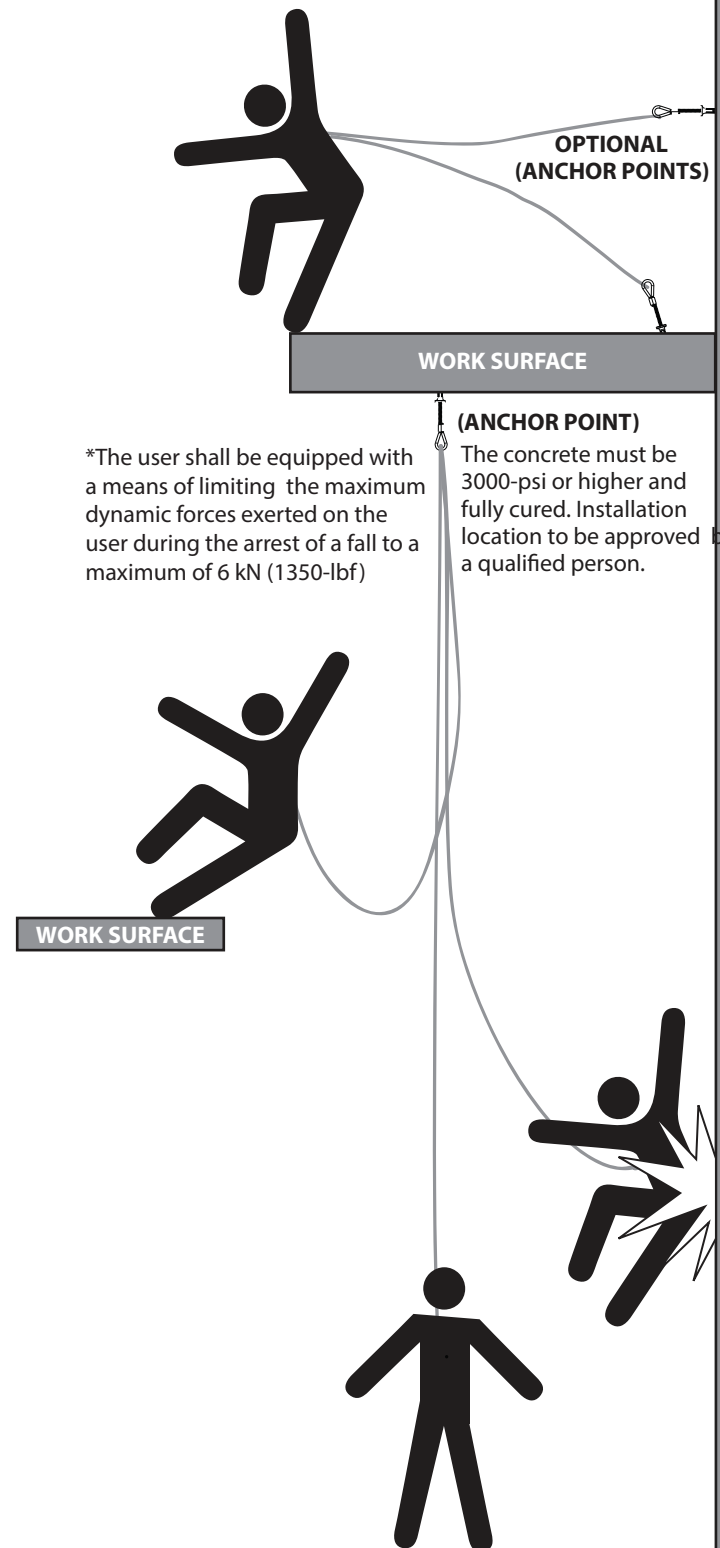

*The user shall be equipped with a means of limiting the maximum dynamic forces exerted on the user during the arrest of a fall to a maximum of 6 kN (1350-lbf)
 (ANCHOR POINT) The concrete must be 3000-psi or higher and fully cured. Installation location to be approved a qualified person.

INSTALLATION IN HOLLOW CORE CONCRETE:

1. Drill a 3/4" (20mm) hole in center of the hollow channel in the hollow core concrete. The hollow core concrete must be at least 5,000-psi (34.5 MPa) concrete with a web thickness of 1-3/4" (44.45mm) thick max 3". Works with 6" hollow core or larger.
2. Never drill any hole closer than 6" (152mm) to any edge or corner.
3. Always inspect the hole carefully when reusing a previously drilled hole.
4. Make sure the toggle bar is fully seated and in lock position. (See activation indicator illustration)
5. The hole plug should be full seated in the drilled hole in the concrete.

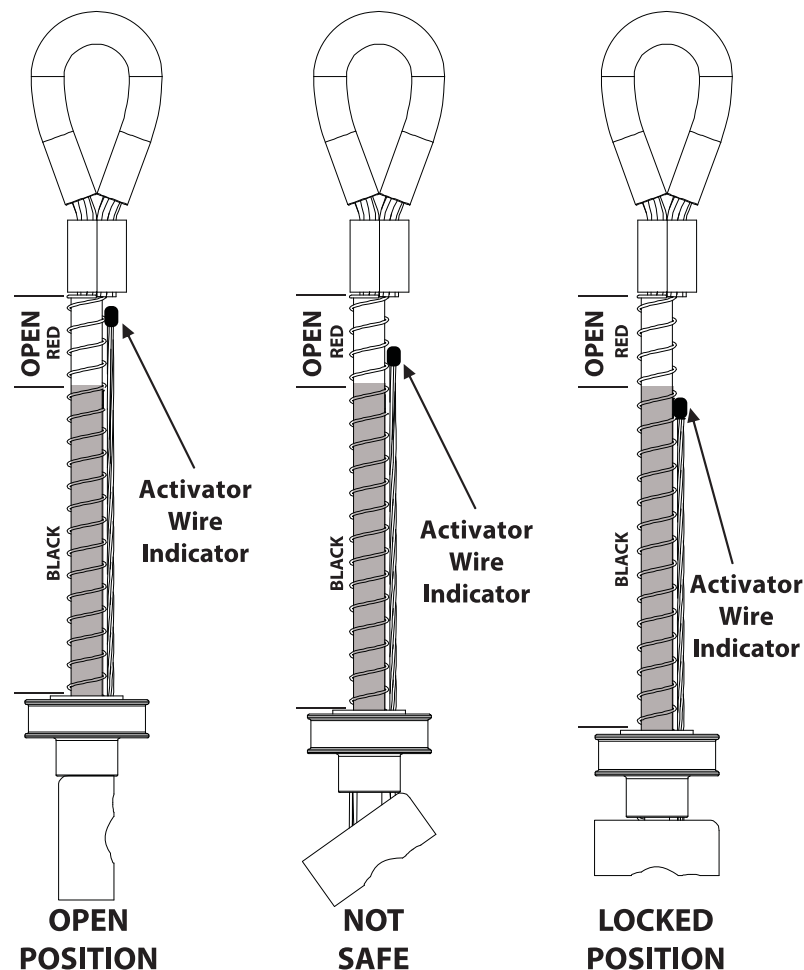

INSTALLATION IN STEEL:

1. Drill a 3/4" (20mm) hole in the steel flange. Steel flange must be at least 1/4" (6.4mm) thick max 3".
2. Never drill a hole closer than 1-1/2" (38mm) to any edge or corner.
3. When reusing a previously drilled hold always inspect the hole carefully.
4. Make sure the toggle bar is fully seated and in lock position. (See activation indicator illustration)

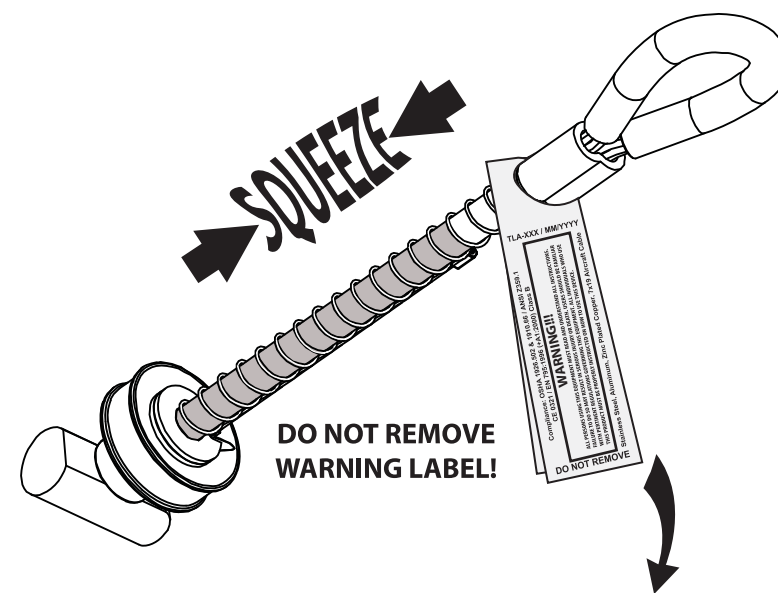

WARNING!!!
 Location of installation of the toggle anchor must be approved by a Engineer or other qualified person to be compatible with any and all structural & operational characteristics of the selected installation location.

Compliance: OSHA 1926.502 & 1910.66 / ANSI Z359.1, ANSI Z359.7 / EN 795:2012 Class A
WARNING!!!
 ALL PERSONS USING THIS EQUIPMENT MUST READ AND UNDERSTAND ALL INSTRUCTIONS. FAILURE TO DO SO MAY RESULT IN SERIOUS INJURY OR DEATH. USERS SHOULD BE FAMILIAR WITH PERTINENT REGULATIONS GOVERNING THIS EQUIPMENT. ALL RESPONSIBLE PERSONS USING THIS PRODUCT MUST BE PROPERLY INSTRUCTED ON HOW TO USE THIS DEVICE.
 Stainless Steel, Aluminum, Zinc Plated Copper, 7x19 Aircraft Cable
 Max Capacity: 310lbs
 ClimbTech
 1-(512) 308-6440
 Toggle Bar: Aircraft Cable
 TLA-xxx / mm/yyyy
 INSPECT BEFORE USE

MINIMUM CLEARANCE 3ft (1m)
 DECK/FLOOR/GROUND LEVEL

All products subjected to fall arresting forces should be removed from service immediately!